

Installation Manual

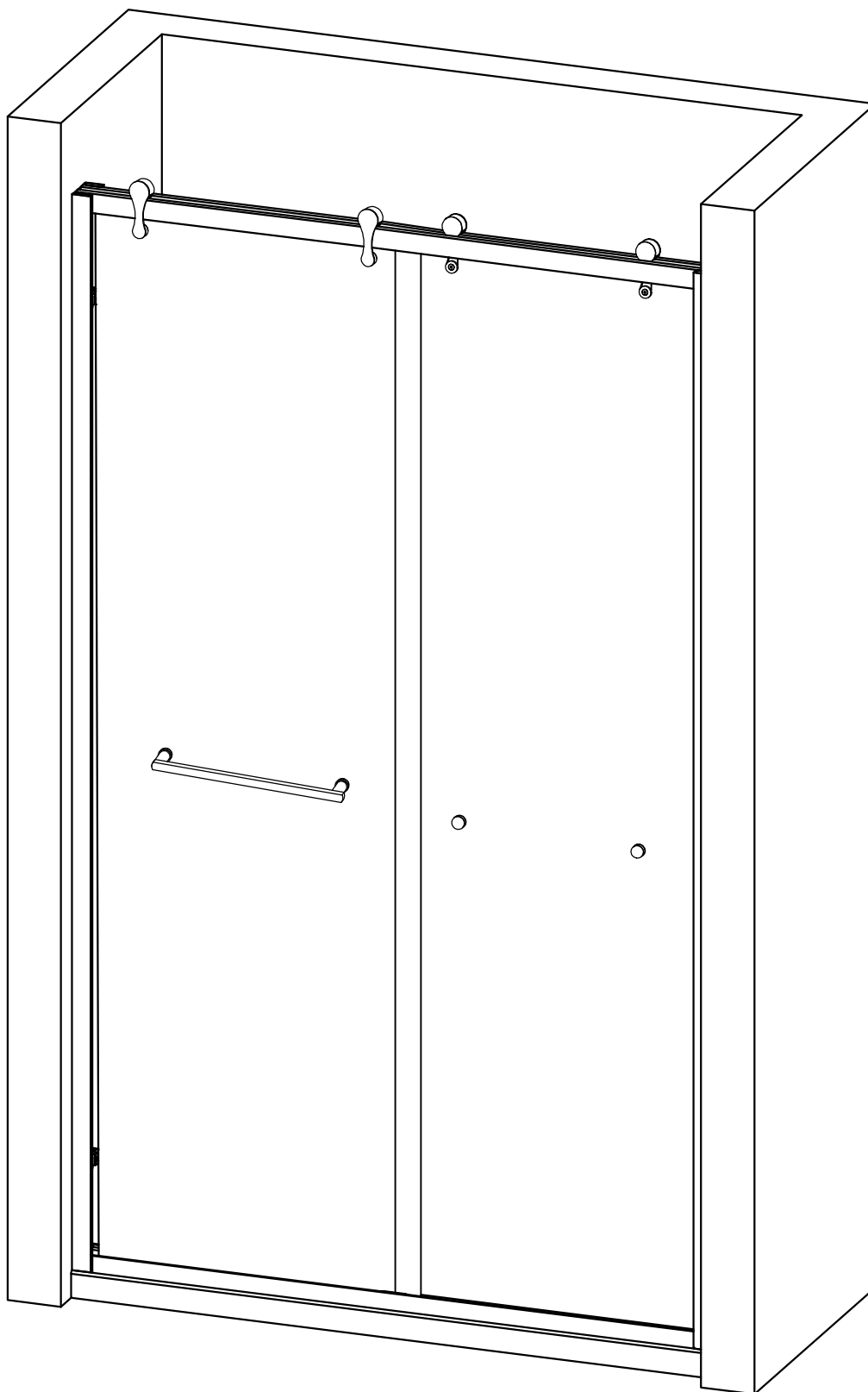

Essence (31P02)

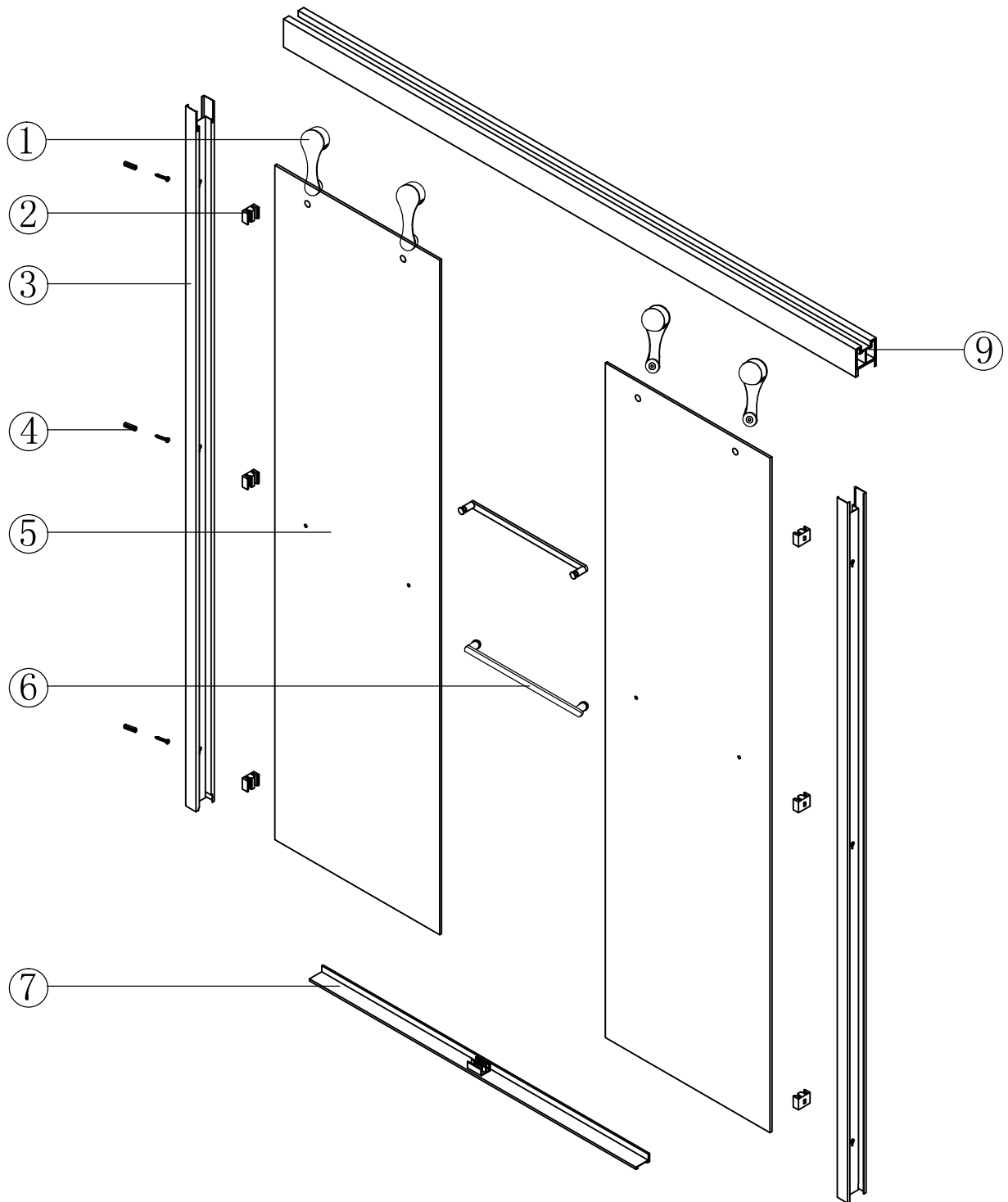

Exploded Diagram

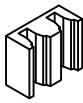
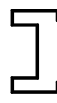

Parts List

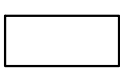
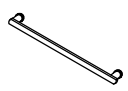
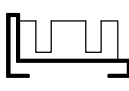
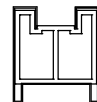
1		x4	2		x6	3		x2	4		x6
5		x2	6		x2	7		x1	8		x1

Tools Required

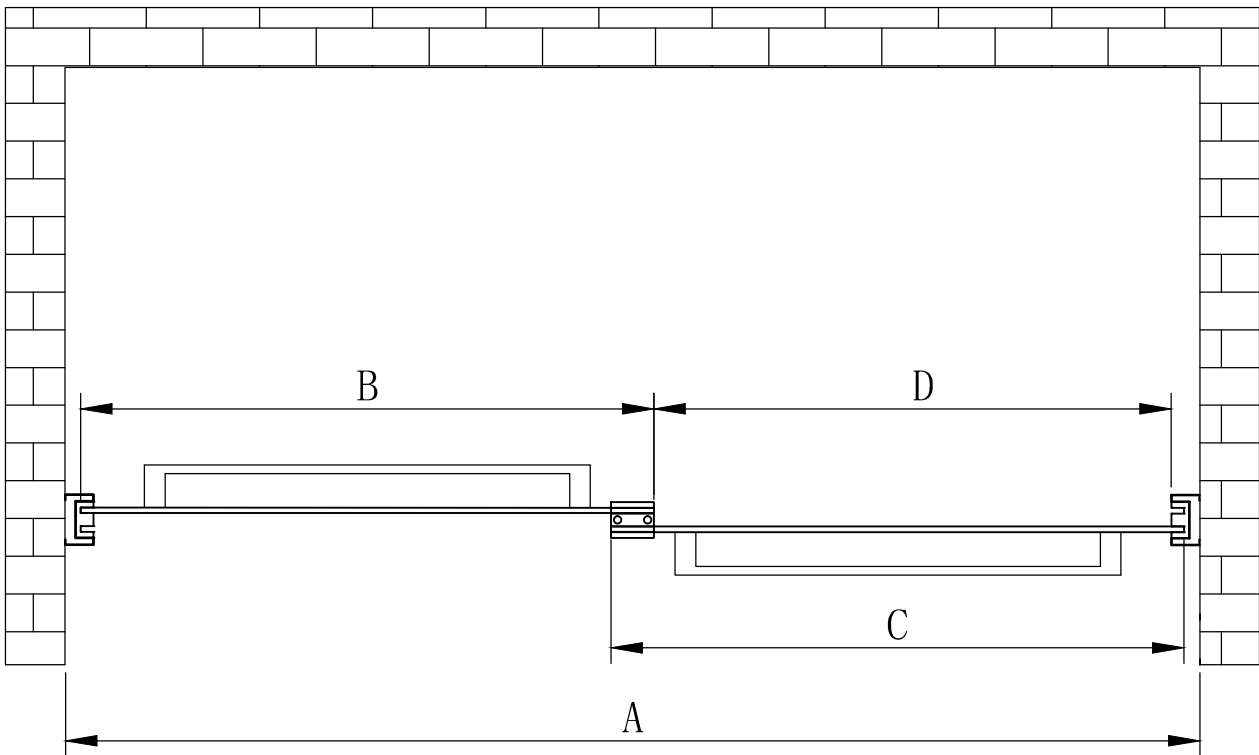
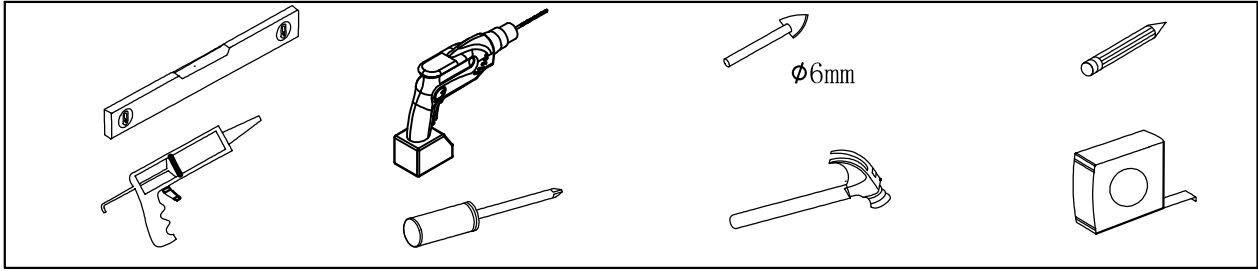

Dimension	Size A	Door B	Door C	Opening space D
48" x 76"	48"	24"	24"	21"
54" x 76"	54"	27"	27"	24"
60" x 76"	60"	30 1/2"	30 1/2"	27"
66" x 76"	66"	33"	33"	30"

Step 1

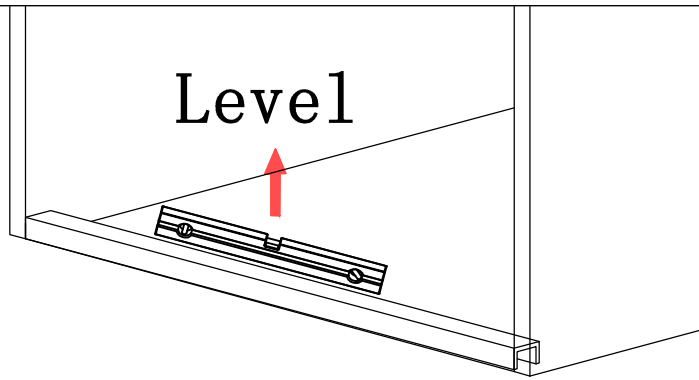

Step 2

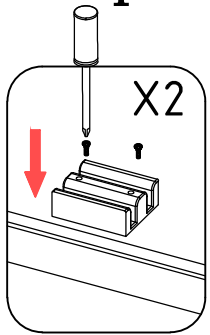

X1

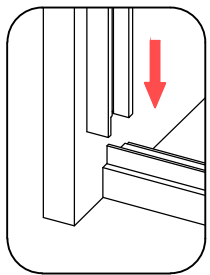

X2

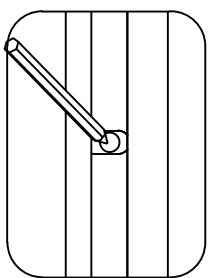

X6

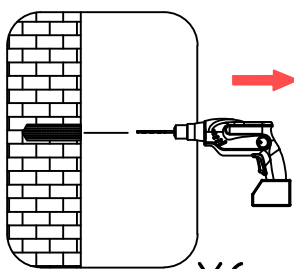
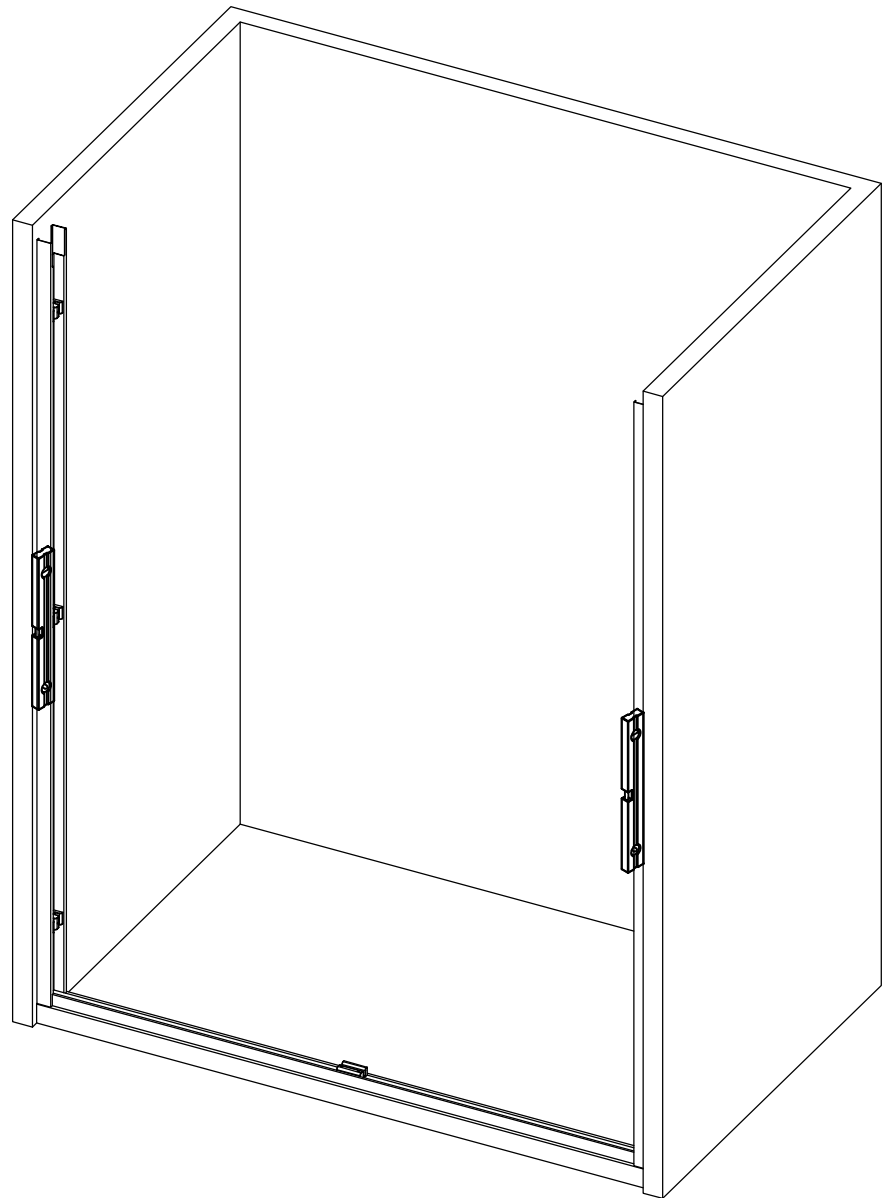

X6

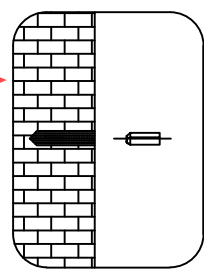

X6

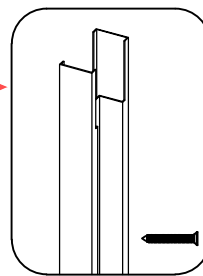

X6

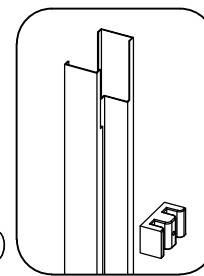

X6

Step 3

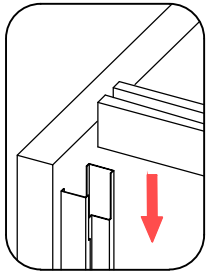

Step 4

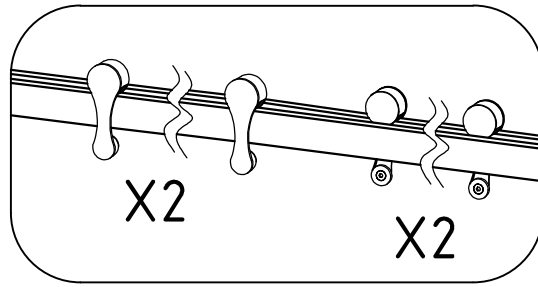

Step 5

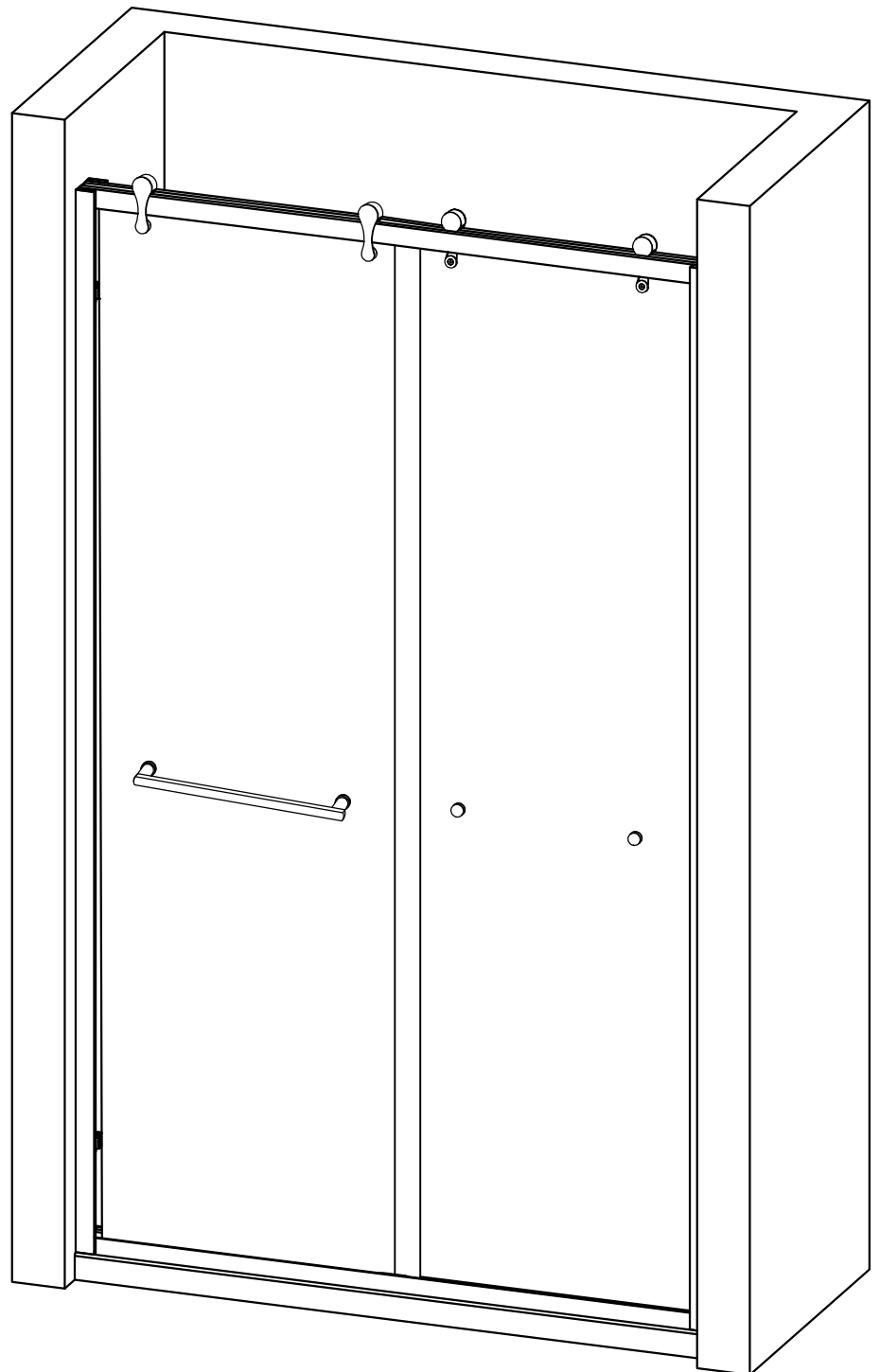
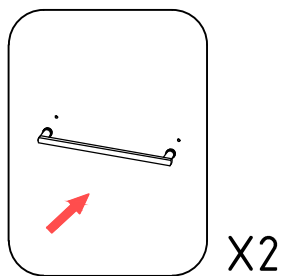
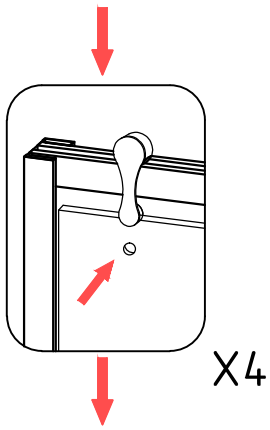

Step 6

DO NOT USE THE ENCLOSURE FOR
24 HOURS AFTER SEALING

